

ENGINEERING  
TOMORROW

*Danfoss*

Catalogue

# Optyma™ Slim Pack

Cost Effective & Quiet Solution

R22, R404A/R507, R134a - 60Hz



<http://www.danfoss.com.br>

**OPTYMA™**  
DANFOSS CONDENSING UNITS



<b>Cost effective &amp; Quiet outdoor solution .....</b>	<b>4</b>
<b>Product range &amp; Features .....</b>	<b>5</b>
Main product features.....	5
Capacity & Operating range.....	5
<b>Application envelope .....</b>	<b>6</b>
<b>Designation system .....</b>	<b>7</b>
<b>General data.....</b>	<b>8</b>
<b>Performance data - Reciprocating condensing unit (MBP) .....</b>	<b>9</b>
<b>Performance data - Scroll condensing unit (MBP) .....</b>	<b>12</b>
<b>Performance data - Reciprocating/Scroll condensing unit (LBP) .....</b>	<b>14</b>
<b>Spare parts .....</b>	<b>15</b>
<b>Dimensions .....</b>	<b>16</b>
<b>Electrical wiring diagrams .....</b>	<b>18</b>



**Quiet solution**

The Optyma™ **Slim Pack** can be located even in residential areas. Smart compressor design. This unit presents low acoustic levels improving comfort and reducing surrounding impact.



**Compact and light for easy handling and transportation**

System designed to perfectly fit into a compact and light housing.



**Well-known Danfoss quality and standards**

We provide the units with highly reliable scroll and reciprocating compressors, micro channel heat exchangers and all needed components which are pre-assembled, integrated and factory tested.



**Easy installation and cleaning**

With quick connections of suction & liquid lines & service ports outside Optyma™ **Slim Pack** is among the fastest & easiest units to install. Easy-to-clean MCHC saves your time & efforts, ensuring longer lifetime & optimized efficiency.



**Tailored for outdoor use**

Danfoss Optyma™ **Slim Pack** is designed for Outdoor & Indoor conditions using corrosion resistant microchannel heat exchangers and housing. The galvanized, painted and salt spray tested housing is used to ensure long lifetime.



**Increase business opportunity with extended range of condensing units**

Danfoss Optyma™ **Slim Pack** extends your business opportunities with models for low and medium temperatures.



For more information, please refer to Coolselector® at [coolselector.danfoss.com](http://coolselector.danfoss.com) or contact Danfoss

### Main product features

Outdoor application



- Wall & floor mounting
- Weather proof housing IP54
- Robust and resistant to corrosion
- Compact design

Micro channel heat exchanger



- Easy & fast cleaning
- Less refrigerant charge
- Longer life time

Service ports outside



- Fast and easy installation
- Quick connections of suction & liquid lines
- Shut off valves on receiver and service valves on service ports for easier & quick servicing

### Capacity & Operating range

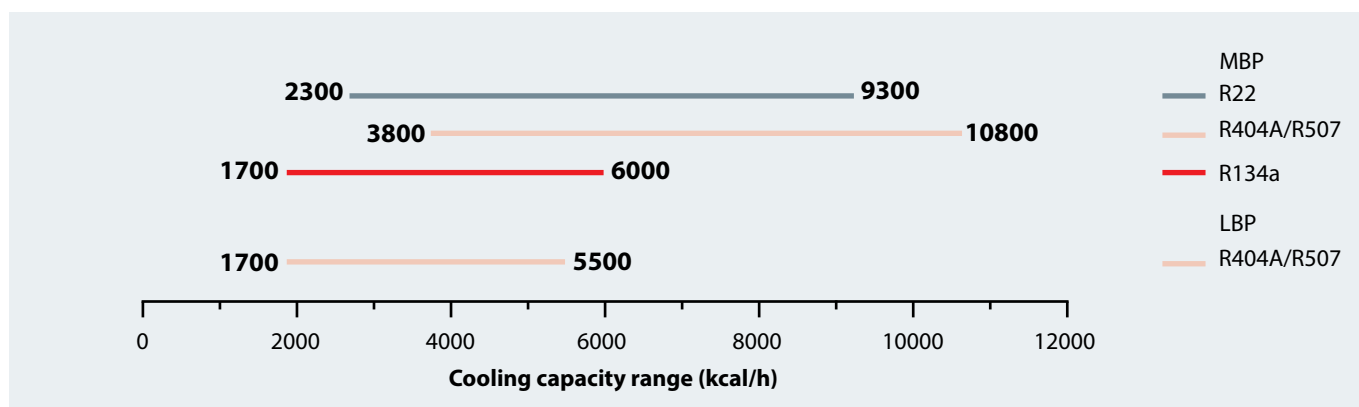

MBP Rated conditions, Saturated suction temperature -10°C. Ambient air temperature +32°C. Superheat 18K. Subcooling 3K  
 LBP Rated conditions, Saturated suction temperature -30°C. Ambient air temperature +32°C. Superheat 18K. Subcooling 3K

Condensing unit limits  
 Ambient temp [°C] Up to 43°C

T Evaporation [°C]	Min	Max
MBP R22	-10	10
MBP R404A/R507	-20	10
MBP R134a	-10	10
LBP R404A/R507	-35	-10

Limits depends on the selected unit

**MBP**

**Refrigerant R404A**

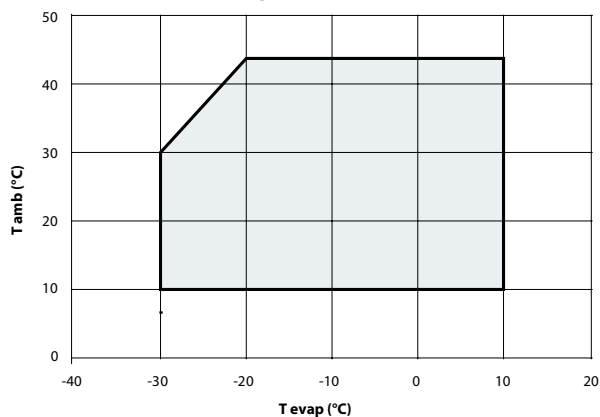

**Refrigerant R134a**

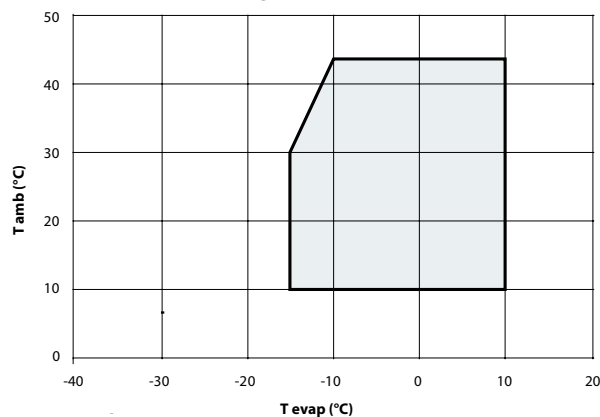

**Refrigerant R22**

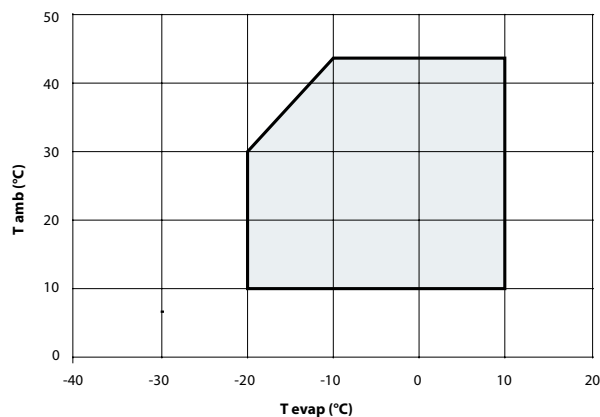

**LBP**

**Refrigerant R404A - Reciprocating**

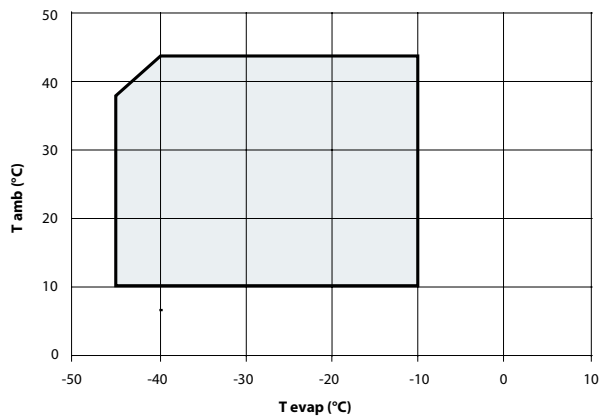

**Refrigerant R404A - Scroll**

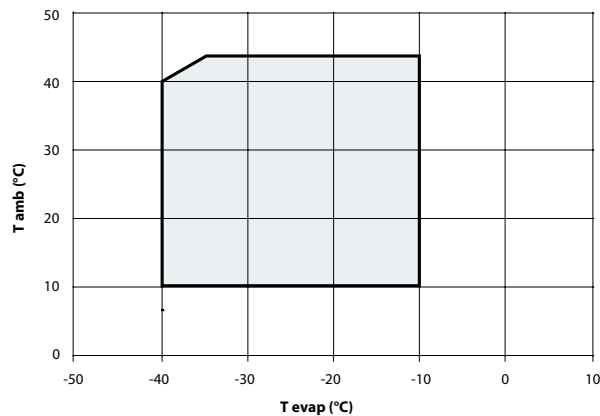

**Designation system for the Optyma™ Slim Pack range**

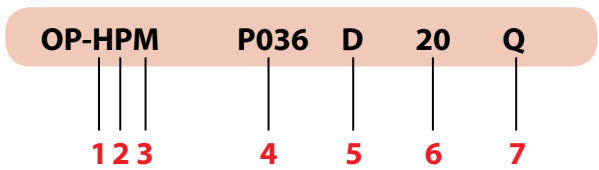

<b>1</b> Application	H = HBP/MBP L = LBP
<b>2</b> Design	P = Packaged unit
<b>3</b> Compressor oil	M = Mineral oil (MT Reciprocating compressor) Z = POE (MTZ/NTZ Reciprocating and LLZ Scroll compressor) U = PVE (MLZ Scroll compressor)
<b>4</b> Compressor type & size	P036 = Piston 036 S038 = Scroll 038
<b>5</b> Condenser technology	D = Microchannel
<b>6</b> Equipment level	Version 20
<b>7</b> Voltage code	N = 230V-1ph-60Hz Comp & Fan Q = 230V-3ph-60Hz Comp & 230V-1ph Fan V = 380V-3ph-60Hz Comp & 230V-1ph Fan

**Label - Designation**



- A: Model
- B: Code number
- C: Serial number and bar code
- D: Supply voltage, Locked Rotor Ampere
- E: Housing service pressure
- F: Refrigerant
- G: Oil

**Main Components**

C.U. With compressor	Pressure switch		Receiver	Contactor electrical	Sequence phase relay	Sight glass	Filter drier	Crankcase heater
	KP1 (LP)	Cartridge (HP)						
Piston	✓	✓	✓	✓		✓	✓	✓
Scroll	✓	✓	✓	✓	✓	✓	✓	✓

**Mechanical data**

Model	Commercial reference	Compressor			Condenser		Fan motor			Receiver	Connection		Weight	
	(HP)	Model	Displ. (m³/h)	Oil charge (L)	Type	Internal volume (L)	No.	Diameter (mm)	Airflow (m³/h)		Suction line (in)	Liquid line (in)	Net (kg)	Gross (kg)
<b>MBP (Recip)</b>														
HPM(Z)P019	1.5	MT(Z)019	6.3	0.95	C2	0.46	1	450	3000	3.7	1/2"	3/8"	57	67
HPM(Z)P022	2.0	MT(Z)022	8.0	0.95	C2	0.46	1	450	3000	3.7	1/2"	3/8"	58	67
HPM(Z)P028	2.5	MT(Z)028	10.1	0.95	C2	0.46	1	450	3000	3.7	1/2"	3/8"	60	69
HPM(Z)P036	3.0	MT(Z)036	12.7	0.95	C3	1.04	1	450	3300	5.8	5/8"	1/2"	70	80
HPM(Z)P040	3.5	MT(Z)040	14.3	0.95	C3	1.04	1	450	3300	5.8	5/8"	1/2"	70	80
HPM(Z)P050	4.5	MT(Z)050	18.0	1.80	C4	1.51	2	450	7200	7.5	7/8"	5/8"	112	124
HPM(Z)P064	5.5	MT(Z)064	22.6	1.80	C4	1.51	2	450	7200	7.5	7/8"	5/8"	114	126
<b>MBP (Scroll)</b>														
HPUS015	2.0	MLZ015	7.1	1.06	C2	0.46	1	450	3000	3.7	3/4"	3/8"	65	74
HPUS019	2.5	MLZ019	9.1	1.06	C3	1.04	1	450	3300	3.7	3/4"	1/2"	75	85
HPUS021	3.0	MLZ021	9.7	1.06	C3	1.04	1	450	3300	5.8	3/4"	1/2"	75	85
HPUS026	3.5	MLZ026	12.0	1.06	C4	1.51	2	450	7200	5.8	3/4"	5/8"	110	120
HPUS030	4.0	MLZ030	14.5	1.57	C4	1.51	2	450	7200	7.5	7/8"	5/8"	117	127
HPUS038	5.0	MLZ038	17.0	1.57	C4	1.51	2	450	7200	7.5	7/8"	5/8"	117	127
<b>LBP (Recip)</b>														
LPZP048	1.5	NTZ048	10.1	0.95	C2	0.46	1	450	3000	3.7	5/8"	3/8"	60	69
LPZP068	2.0	NTZ068	14.3	0.95	C2	0.46	1	450	3000	3.7	5/8"	3/8"	60	69
<b>LBP (Scroll)</b>														
LPZS013	4.0	LLZ013	14.2	1.62	C4	1.51	2	450	7200	7.5	3/4"	5/8"	121	131
LPZS015	5.0	LLZ015	17.6	1.62	C4	1.51	2	450	7200	7.5	3/4"	5/8"	121	131
LPZS018	6.0	LLZ018	20.5	1.62	C4	1.51	2	450	7200	7.5	3/4"	5/8"	122	132

**Electrical data**

Condensing unit										Compressor									Fan motor		
60Hz	230V 1Ph (N)			230V 3Ph (Q)			380V 3Ph (V)			230V 1Ph			230V 3Ph			380V 3Ph			No.	220V 1Ph	Power consumption
Model	LRA	RLA	MCA	LRA	RLA	MCA	LRA	RLA	MCA	LRA	RLA	MCC	LRA	RLA	MCC	LRA	RLA	MCC		FLA	W
<b>MBP (Recip)</b>																					
HPM(Z)P019	57	11	16	44	8	12	29	6	9	52	10	14	39	7	10	24	5	5	1	0.96	230
HPM(Z)P022	55	14	20	44	10	14	28	6	9	50	13	18	39	9	12	24	5	7	1	0.96	230
HPM(Z)P028	87	20	28	63	13	19	38	8	11	82	19	26	58	12	17	33	7	10	1	0.96	230
HPM(Z)P036	90	23	33	80	14	20	41	9	12	85	22	31	75	13	18	36	8	11	1	0.96	230
HPM(Z)P040	106	27	38	105	19	26	66	10	15	101	26	36	100	18	24	61	9	12	1	0.96	230
HPM(Z)P050	121	29	40	122	21	29	85	13	18	116	28	38	117	20	27	80	12	15	2	0.96	230
HPM(Z)P064	150	36	50	144	24	33	79	15	22	145	35	48	139	23	31	74	14	19	2	0.96	230
<b>MBP (Scroll)</b>																					
HPUS015	75	16	22	66	12	17	46	8	11	70	15	20	61	11	16	41	7	9	1	0.96	230
HPUS019	103	22	31	101	15	21	58	10	14	98	21	26	96	14	19	53	9	13	1	0.96	230
HPUS021	103	23	33	101	16	22	58	10	14	98	22	26	96	15	19	53	9	13	1	0.96	230
HPUS026	122	30	42	102	19	27	59	13	18	117	29	33	97	19	24	54	12	14	2	0.96	230
HPUS030	157	35	49	127	23	32	88	15	21	152	34	40	122	22	28	83	14	16	2	0.96	230
HPUS038	167	40	56	130	26	37	88	17	24	162	39	47	125	25	28	83	16	19	2	0.96	230
<b>LBP (Recip)</b>																					
LPZP048	50	11	16	38	9	13	28	5	8	45	10	14	33	8	11	23	5	6	1	0.96	230
LPZP068	78	17	24	54	12	17	35	8	11	73	16	22	50	12	16	30	7	10	1	0.96	230
<b>LBP (Scroll)</b>																					
LPZS013	-	-	-	129	20	28	87	11	15	-	-	-	124	19	26	82	10	15	2	0.96	230
LPZS015	-	-	-	187	21	30	88	14	19	-	-	-	182	20	31	83	13	19	2	0.96	230
LPZS018	-	-	-	191	23	32	113	16	22	-	-	-	186	22	33	108	15	22	2	0.96	230

**LRA:** Locked Rotor Amperage, **RLA:** Full Load Amperage, **MCC:** Maximum Continuous Current, **FLA:** Full Load Amperage



MBP R22

Model number	Code number	Electrical code	Compressor model	Fans	Ambient temperature (°C)	Cooling capacity range in (Kcal/h) at evaporating temperature (°C)												Sound pressure level at 3m (dB)
						-15°C		-10°C		-5°C		0°C		5°C		10°C		
						CC	PC	CC	PC	CC	PC	CC	PC	CC	PC	CC	PC	
HPMP019	115F0627 115F0628 115F0629	N Q V	MT019	1	32	1535	1237	2068	1364	2707	1484	3456	1595	4322	1695	5304	1783	57
					35	1451	1259	1964	1392	2578	1519	3299	1637	4132	1745	5079	1843	
					38	-	-	1859	1419	2448	1552	3140	1679	3940	1796	4850	1904	
					43	-	-	1684	1462	2228	1608	2869	1748	3612	1881	4461	2006	
HPMP022	115F0630 115F0631 115F0632	N Q V	MT022	1	32	2244	1529	2953	1723	3756	1907	4656	2078	5653	2235	6746	2374	58
					35	2107	1554	2796	1754	3576	1947	4448	2128	5414	2296	6472	2448	
					38	-	-	2638	1783	3393	1984	4236	2175	5169	2355	6192	2520	
					43	-	-	2372	1822	3084	2039	3879	2248	4757	2448	5718	2635	
HPMP028	115F0633 115F0634 115F0635	N Q V	MT028	1	32	3251	2153	4113	2379	5067	2599	6109	2815	7238	3025	8447	3232	55
					35	3091	2178	3932	2417	4859	2655	5870	2890	6963	3124	8134	3357	
					38	-	-	3746	2453	4646	2708	5626	2965	6683	3222	7814	3482	
					43	-	-	3430	2508	4282	2794	5208	3086	6204	3384	7266	3689	
HPMP036	115F0636 115F0637 115F0638	N Q V	MT036	1	32	4246	2709	5323	2994	6506	3287	7793	3587	9181	3895	10662	4215	57
					35	4033	2761	5085	3059	6238	3367	7491	3686	8839	4016	10277	4360	
					38	-	-	4844	3124	5968	3449	7184	3787	8493	4139	9886	4507	
					43	-	-	4437	3231	5506	3585	6662	3957	7900	4347	9217	4757	
HPMP040	115F0639 115F0640 115F0641	N Q V	MT040	1	32	4523	3251	5685	3630	6977	4007	8404	4380	9965	4749	11662	5117	57
					35	4290	3318	5436	3713	6711	4110	8114	4506	9650	4903	11318	5303	
					38	-	-	5188	3790	6441	4207	7823	4627	9333	5053	10970	5486	
					43	-	-	4770	3903	5992	4355	7334	4817	8799	5291	10385	5779	
HPMP050	115F0642 115F0643 115F0644	N Q V	MT050	2	32	5407	3497	6962	3799	8742	4092	10751	4385	12987	4684	15446	4995	63
					35	5169	3588	6670	3915	8388	4232	10325	4546	12483	4866	14857	5196	
					38	-	-	6381	4024	8036	4366	9903	4705	11982	5046	14272	5396	
					43	-	-	5905	4188	7457	4576	9207	4957	11157	5338	13305	5726	
HPMP064	115F0645 115F0646 115F0647	N Q V	MT064	2	32	6876	4309	8740	4710	10877	5130	13284	5575	15955	6048	18877	6557	60
					35	6605	4416	8399	4838	10457	5279	12777	5744	15353	6238	18173	6767	
					38	-	-	8056	4965	10034	5427	12265	5913	14745	6428	17462	6978	
					43	-	-	7488	5166	9328	5666	11410	6189	13726	6740	16271	7324	

Superheat: 18K  
Subcooling: 3K

CC: Cooling capacity (Kcal/h)  
PC: Power input (W)



For more information, please refer to Coolselector® at [coolselector.danfoss.com](http://coolselector.danfoss.com) or contact Danfoss

**MBP R404A**

Model number	Code number	Electrical code	Compressor model	Fans	Ambient temperature (°C)	Cooling capacity range in (Kcal/h) at evaporating temperature (°C)																Sound pressure level at 3m (dB)
						-25°C		-20°C		-15°C		-10°C		-5°C		0°C		5°C		10°C		
						CC	PC	CC	PC	CC	PC	CC	PC	CC	PC	CC	PC	CC	PC	CC	PC	
HPZP019	115F0600 115F0601 115F0602	N Q V	MTZ019	1	32	984	1366	1434	1539	1962	1687	2570	1815	3261	1925	4037	2023	4896	2114	5836	2200	60
					35	895	1353	1329	1542	1835	1704	2419	1844	3082	1967	3826	2076	4650	2175	5554	2270	
					38	-	-	1222	1539	1706	1716	2264	1870	2899	2005	3610	2125	4400	2235	5267	2339	
					43	-	-	1041	1522	1488	1725	2002	1903	2586	2061	3244	2201	3975	2329	4779	2449	
HPZP022	115F0603 115F0604 115F0605	N Q V	MTZ022	1	32	1493	1513	2024	1691	2648	1864	3369	2035	4186	2207	5097	2383	6098	2563	7183	2752	61
					35	1398	1528	1908	1716	2505	1901	3192	2083	3971	2266	4840	2451	5795	2642	6830	2840	
					38	-	-	1785	1737	2354	1933	3008	2126	3748	2320	4573	2516	5481	2718	6467	2926	
					43	-	-	1569	1758	2088	1975	2684	2188	3358	2402	4111	2617	4941	2836	5846	3062	
HPZP028	115F0606 115F0607 115F0608	N Q V	MTZ028	1	32	2035	1927	2668	2171	3389	2411	4199	2651	5094	2893	6069	3141	7119	3396	8236	3662	58
					35	1908	1941	2516	2199	3207	2453	3980	2707	4833	2962	5763	3223	6764	3490	7830	3768	
					38	-	-	2362	2222	3020	2491	3756	2759	4567	3028	5452	3301	6404	3582	7419	3872	
					43	-	-	2094	2249	2699	2542	3371	2834	4113	3127	4920	3423	5791	3726	6725	4038	
HPZP036	115F0609 115F0610 115F0611	N Q V	MTZ036	1	32	2490	2230	3324	2546	4285	2874	5369	3218	6575	3581	7895	3965	9319	4376	10838	4816	60
					35	2313	2239	3111	2568	4029	2910	5065	3270	6215	3648	7475	4049	8836	4476	10289	4934	
					38	-	-	2901	2587	3775	2944	4760	3318	5856	3713	7055	4130	8352	4575	9741	5050	
					43	-	-	2550	2613	3351	2993	4254	3393	5256	3815	6356	4260	7550	4734	8833	5239	
HPZP040	115F0612 115F0613 115F0614	N Q V	MTZ040	1	32	2816	2760	3739	3109	4791	3475	5966	3863	7258	4280	8655	4730	10145	5221	11716	5759	60
					35	2623	2776	3506	3142	4509	3524	5629	3929	6859	4361	8191	4828	9612	5334	11112	5886	
					38	-	-	3275	3173	4229	3572	5292	3992	6461	4441	7726	4923	9080	5444	10511	6010	
					43	-	-	2893	3214	3763	3641	4733	4089	5799	4564	6955	5072	8197	5617	9518	6207	
HPZP050	115F0615 115F0616 115F0617	N Q V	MTZ050	2	32	3732	3298	4966	3672	6401	4026	8048	4366	9912	4698	11999	5028	14304	5362	16827	5706	66
					35	3458	3307	4647	3710	6028	4092	7610	4460	9402	4819	11405	5176	13622	5535	16048	5904	
					38	-	-	4322	3736	5646	4148	7161	4545	8878	4933	10799	5316	12926	5702	15257	6097	
					43	-	-	3769	3752	4993	4216	6394	4664	7982	5101	9763	5532	11740	5965	13912	6404	
HPZP064	115F0618 115F0619 115F0620	N Q V	MTZ064	2	32	4672	4038	6164	4565	7881	5076	9826	5580	11997	6088	14384	6611	16976	7156	19758	7733	63
					35	4334	4040	5763	4600	7405	5141	9264	5672	11337	6205	13617	6748	16097	7313	18762	7907	
					38	-	-	5360	4622	6926	5194	8695	5754	10670	6313	12845	6879	15212	7464	17761	8076	
					43	-	-	4684	4624	6119	5253	7739	5865	9549	6471	11546	7080	13727	7702	16086	8348	

Superheat: 18K      CC: Cooling capacity (Kcal/h)  
Subcooling: 3K      PC: Power input (W)



For more information, please refer to Coolselector® at [coolselector.danfoss.com](http://coolselector.danfoss.com) or contact Danfoss

**MBP R134a**

Model number	Code number	Electrical code	Compressor model	Fans	Ambient temperature (°C)	Cooling capacity range in (Kcal/h) at evaporating temperature (°C)								Sound pressure level at 3m (dB)		
						-10°C		-5°C		0°C		5°C			10°C	
						CC	PC	CC	PC	CC	PC	CC	PC		CC	PC
HPZP019	115F0600 115F0601 115F0602	N Q V	MTZ019	1	32	1504	1014	1949	1084	2493	1150	3146	1210	3915	1267	60
					35	1416	1034	1849	1112	2379	1185	3013	1256	3763	1324	
					38	1327	1049	1748	1134	2262	1217	2879	1297	3607	1378	
					43	1179	1062	1577	1160	2064	1258	2650	1357	3341	1458	
HPZP022	115F0603 115F0604 115F0605	N Q V	MTZ022	1	32	1905	1216	2491	1326	3188	1431	4001	1529	4933	1621	61
					35	1815	1238	2384	1355	3059	1467	3846	1575	4747	1679	
					38	1724	1256	2275	1380	2926	1501	3685	1619	4556	1734	
					43	1570	1275	2085	1412	2695	1548	3407	1684	4224	1820	
HPZP028	115F0606 115F0607 115F0608	N Q V	MTZ028	1	32	2494	1522	3223	1688	4051	1849	4980	2005	6010	2156	58
					35	2373	1541	3083	1715	3889	1887	4792	2057	5790	2224	
					38	2250	1556	2941	1740	3723	1924	4598	2107	5565	2290	
					43	2041	1574	2698	1775	3438	1980	4266	2187	5179	2398	
HPZP036	115F0609 115F0610 115F0611	N Q V	MTZ036	1	32	3303	1985	4192	2225	5212	2457	6369	2679	7663	2888	60
					35	3136	2007	4002	2256	4997	2499	6121	2733	7379	2956	
					38	2969	2025	3813	2282	4779	2536	5871	2783	7091	3022	
					43	2695	2043	3498	2317	4414	2590	5447	2860	6601	3125	
HPZP040	115F0612 115F0613 115F0614	N Q V	MTZ040	1	32	3946	2452	4866	2737	5924	3019	7127	3294	8480	3562	60
					35	3700	2463	4607	2757	5648	3049	6833	3337	8163	3621	
					38	3461	2468	4354	2771	5379	3074	6543	3377	7851	3677	
					43	3080	2462	3949	2781	4947	3105	6077	3431	7346	3759	
HPZP050	115F0615 115F0616 115F0617	N Q V	MTZ050	2	32	4207	2578	5584	2781	7209	2970	9096	3152	11256	3329	66
					35	4047	2632	5395	2853	6980	3061	8817	3260	10917	3454	
					38	3872	2682	5188	2923	6730	3149	8516	3366	10554	3579	
					43	3549	2752	4807	3027	6275	3287	7970	3537	9903	3781	
HPZP064	115F0618 115F0619 115F0620	N Q V	MTZ064	2	32	5431	3170	7172	3471	9199	3761	11514	4046	14113	4333	63
					35	5204	3222	6899	3547	8867	3859	11111	4164	13628	4470	
					38	4963	3268	6613	3618	8522	3952	10694	4279	13128	4606	
					43	4534	3322	6106	3718	7915	4095	9968	4461	12264	4824	

 Superheat: 18K  
 Subcooling: 3K

 CC: Cooling capacity (Kcal/h)  
 PC: Power input (W)

 For more information, please refer to Coolselector® at [coolselector.danfoss.com](http://coolselector.danfoss.com) or contact Danfoss

**MBP R404A**

Model number	Code number	Electrical code	Compressor model	Fans	Ambient temperature (°C)	Cooling capacity range in (Kcal/h) at evaporating temperature (°C)														Sound pressure level at 3m (dB)		
						-25°C		-20°C		-15°C		-10°C		-5°C		0°C		5°C			10°C	
						CC	PC	CC	PC	CC	PC	CC	PC	CC	PC	CC	PC	CC	PC		CC	PC
HPUS015	115F0660 115F0661 115F0662	N Q V	MLZ015	1	32	1975	2033	2506	2076	3099	2123	3761	2174	4500	2228	5319	2283	6224	2339	7219	2394	57
					35	1842	2154	2357	2201	2928	2252	3565	2306	4272	2362	5058	2420	5927	2478	6885	2535	
					38	-	-	2202	2333	2753	2388	3363	2445	4039	2504	4791	2565	5624	2625	6547	2685	
					43	-	-	1932	2573	2446	2634	3012	2697	3638	2761	4334	2825	5109	2889	5974	2953	
HPUS019	115F0663 115F0664 115F0665	N Q V	MLZ019	1	32	2783	2373	3440	2474	4187	2554	5033	2621	5983	2685	7041	2753	8213	2830	9502	2922	58
					35	2636	2499	3265	2615	3980	2706	4790	2779	5702	2845	6722	2911	7855	2983	9108	3067	
					38	-	-	3085	2758	3769	2860	4543	2941	5417	3009	6398	3074	7494	3141	8714	3219	
					43	-	-	2773	2993	3403	3117	4119	3213	4932	3288	5851	3353	6886	3415	8051	3482	
HPUS021	115F0666 115F0667 115F0668	N Q V	MLZ021	1	32	2939	2453	3634	2616	4426	2726	5322	2804	6323	2870	7431	2944	8649	3046	9976	3194	58
					35	2782	2605	3449	2775	4208	2890	5066	2971	6029	3038	7098	3111	8278	3211	9568	3357	
					38	-	-	3258	2948	3984	3067	4807	3150	5731	3218	6761	3290	7902	3388	9157	3532	
					43	-	-	2926	3270	3597	3395	4360	3480	5221	3548	6188	3618	7266	3713	8469	3852	
HPUS026	115F0669 115F0670 115F0671	N Q V	MLZ026	2	32	3824	3582	4723	3744	5773	3861	6981	3947	8350	4016	9881	4080	11578	4152	13436	4244	58
					35	3634	3758	4494	3929	5501	4053	6661	4143	7977	4214	9455	4278	11096	4348	12900	4436	
					38	-	-	4260	4127	5223	4257	6333	4352	7598	4424	9021	4488	10607	4555	12359	4639	
					43	-	-	3854	4488	4743	4628	5772	4729	6951	4803	8284	4866	9780	4928	11447	5005	
HPUS030	115F0672 115F0673 115F0674	N Q V	MLZ030	2	32	4427	4175	5473	4241	6686	4329	8072	4430	9635	4538	11380	4649	13307	4758	15419	4859	60
					35	4206	4405	5205	4465	6365	4549	7695	4648	9199	4758	10882	4873	12748	4987	14801	5096	
					38	-	-	4929	4708	6037	4786	7310	4884	8754	4994	10375	5111	12179	5230	14175	5346	
					43	-	-	4451	5161	5470	5228	6648	5318	7991	5426	9510	5545	11214	5670	13118	5797	
HPUS038	115F0675 115F0676 115F0677	N Q V	MLZ038	2	32	5178	4974	6447	5031	7870	5136	9466	5273	11247	5425	13227	5578	15417	5715	17829	5823	61
					35	4903	5244	6126	5303	7495	5410	9027	5549	10736	5704	12639	5861	14749	6003	17082	6117	
					38	-	-	5792	5591	7106	5699	8574	5840	10213	5999	12039	6159	14071	6306	16328	6426	
					43	-	-	5200	6106	6424	6218	7787	6362	9310	6525	11011	6692	12916	6846	15052	6976	

Superheat: 18K  
Subcooling: 3K

CC: Cooling capacity (Kcal/h)  
PC: Power input (W)



For more information, please refer to Coolselector® at [coolselector.danfoss.com](http://coolselector.danfoss.com) or contact Danfoss

**MBP R134a**

Model number	Code number	Electrical code	Compressor model	Fans	Ambient temperature (°C)	Cooling capacity range in (Kcal/h) at evaporating temperature (°C)								Sound pressure level at 3m (dB)		
						-10°C		-5°C		0°C		5°C			10°C	
						CC	PC	CC	PC	CC	PC	CC	PC		CC	PC
HPUS015	115F0660 115F0661 115F0662	N Q V	MLZ015	1	32	2381	1273	2979	1315	3664	1360	4432	1411	5280	1469	57
					35	2302	1334	2889	1378	3560	1426	4312	1479	5143	1538	
					38	2222	1397	2796	1444	3452	1495	4189	1550	5002	1612	
					43	2084	1509	2635	1562	3266	1617	3975	1678	4756	1744	
HPUS019	115F0663 115F0664 115F0665	N Q V	MLZ019	1	32	3068	1573	3842	1634	4727	1692	5717	1754	6811	1823	58
					35	2966	1650	3726	1716	4592	1778	5562	1842	6635	1912	
					38	2863	1731	3606	1802	4453	1868	5403	1934	6453	2007	
					43	2685	1874	3399	1955	4214	2028	5128	2101	6139	2177	
HPUS021	115F0666 115F0667 115F0668	N Q V	MLZ021	1	32	3256	1625	4082	1692	5008	1751	6042	1812	7189	1882	58
					35	3146	1704	3959	1778	4868	1842	5880	1905	7001	1977	
					38	3032	1786	3832	1867	4723	1937	5713	2004	6809	2077	
					43	2835	1926	3612	2023	4473	2104	5426	2180	6477	2258	
HPUS026	115F0669 115F0670 115F0671	N Q V	MLZ026	2	32	4113	2567	5157	2625	6358	2686	7712	2752	9211	2822	58
					35	3980	2661	5004	2725	6183	2792	7511	2859	8983	2928	
					38	3843	2759	4848	2831	6004	2902	7306	2973	8747	3042	
					43	3608	2931	4578	3018	5693	3100	6950	3178	8340	3250	
HPUS030	115F0672 115F0673 115F0674	N Q V	MLZ030	2	32	4917	2961	6158	3031	7579	3103	9178	3183	10949	3276	60
					35	4756	3079	5974	3155	7368	3231	8935	3313	10671	3408	
					38	4592	3202	5786	3285	7152	3365	8687	3451	10385	3548	
					43	4308	3417	5461	3513	6778	3604	8257	3698	9893	3802	
HPUS038	115F0675 115F0676 115F0677	N Q V	MLZ038	2	32	5716	3354	7149	3445	8809	3554	10676	3677	12733	3809	61
					35	5533	3502	6934	3597	8559	3708	10390	3833	12408	3969	
					38	5349	3660	6714	3757	8302	3871	10095	4000	12073	4138	
					43	5036	3942	6338	4044	7860	4164	9583	4298	11488	4442	

Superheat: 18K  
Subcooling: 3K

CC: Cooling capacity (Kcal/h)  
PC: Power input (W)



For more information, please refer to Coolselector® at [coolselector.danfoss.com](http://coolselector.danfoss.com) or contact Danfoss

**LBP R404A (Recip)**

Model number	Code number	Electrical code	Compressor model	Fans	Ambient temperature (°C)	Cooling capacity range in (Kcal/h) at evaporating temperature (°C)												Sound pressure level at 3m (dB)		
						-40°C		-35°C		-30°C		-25°C		-20°C		-15°C			-10°C	
						CC	PC	CC	PC	CC	PC	CC	PC	CC	PC	CC	PC		CC	PC
LPZP048	115F0621 115F0622 115F0623	N Q V	NTZ048	1	32	736	1050	1097	1313	1524	1576	2022	1831	2593	2075	3239	2300	3960	2503	57
					35	664	1028	1006	1303	1412	1578	1884	1847	2426	2105	3039	2347	3726	2567	
					38	593	1002	917	1288	1300	1575	1748	1858	2259	2131	2840	2388	3492	2624	
					43	476	947	770	1250	1117	1557	1520	1862	1983	2158	2509	2441	3101	2705	
LPZP068	115F0624 115F0625 115F0626	N Q V	NTZ068	1	32	1269	1733	1763	2012	2337	2311	2992	2635	3726	2992	4535	3390	5417	3839	51
					35	1163	1741	1631	2032	2176	2344	2797	2682	3493	3054	4264	3468	5104	3933	
					38	1061	1746	1506	2050	2021	2376	2608	2728	3267	3116	3998	3546	4797	4028	
					43	903	1748	1306	2076	1773	2426	2305	2805	2903	3219	3567	3678	4297	4189	

Superheat: 18K      CC: Cooling capacity (Kcal/h)  
 Subcooling: 3K      PC: Power input (W)

**LBP R404A (Scroll)**

Model number	Code number	Electrical code	Compressor model	Fans	Ambient temperature (°C)	Cooling capacity range in (Kcal/h) at evaporating temperature (°C)												Sound pressure level at 3m (dB)		
						-40°C		-35°C		-30°C		-25°C		-20°C		-15°C			-10°C	
						CC	PC	CC	PC	CC	PC	CC	PC	CC	PC	CC	PC		CC	PC
LPZS013	115F0680 115F0681	Q V	LLZ013	2	32	2231	3369	2884	3589	3644	3813	4523	4035	5530	4248	6674	4446	7962	4623	64
					35	2125	3460	2755	3684	3486	3918	4327	4153	5289	4383	6381	4602	7611	4804	
					38	2015	3556	2623	3785	3323	4027	4125	4275	5042	4521	6082	4760	7253	4985	
					43			2393	3967	3040	4221	3779	4487	4618	4759	5569	5028	6643	5290	
LPZS015	115F0682 115F0683	Q V	LLZ015	2	32	2738	3902	3494	4165	4401	4461	5471	4778	6720	5103	8158	5428	9795	5743	64
					35	2611	4008	3338	4272	4205	4574	5228	4903	6420	5245	7793	5592	9359	5934	
					38	2481	4126	3178	4388	4005	4696	4979	5034	6115	5393	7424	5760	8918	6127	
					43			2900	4610	3661	4921	4554	5273	5593	5654	6793	6052	8169	6458	
LPZS018	115F0684 115F0685	Q V	LLZ018	2	32	3229	4328	4115	4633	5172	4978	6415	5349	7856	5736	9507	6128	11376	6518	64
					35	3078	4451	3929	4756	4940	5108	6125	5493	7500	5898	9075	6314	10861	6733	
					38	2922	4588	3738	4891	4702	5248	5830	5644	7137	6067	8637	6506	10340	6951	
					43			3406	5148	4291	5509	5323	5920	6517	6367	7890	6840	9455	7328	

Superheat: 18K      CC: Cooling capacity (Kcal/h)  
 Subcooling: 3K      PC: Power input (W)



For more information, please refer to Coolselector® at [coolselector.danfoss.com](http://coolselector.danfoss.com) or contact Danfoss

**Mechanical components**

**Reciprocating compressor**

Condensing unit		HPM(Z)P019	HPM(Z)P022	HPM(Z)P028	HPM(Z)P036	HPM(Z)P040	HPM(Z)P050	HPM(Z)P064	LPZP048	LPZP068
Oil compressor	R22	7754001	7754001	7754001	7754001	7754001	7754001	7754001	-	-
	R404A/R507	7754019	7754019	7754019	7754019	7754019	7754019	7754019	7754025	7754025
Condenser		021Z0590E	021Z0590E	021Z0590E	021Z0591E	021Z0591E	021Z0592E	021Z0592E	021Z0590E	021Z0590E
Fan motor		119-7401E	119-7401E	119-7401E	119-7401E	119-7401E	119-7401E	119-7401E	119-7401E	119-7401E
Fan blade		191U139420E	191U139420E	191U139420E	191U139420E	191U139420E	191U139420E	191U139420E	191U139420E	191U139420E
Fan grill		118U3985E	118U3985E	118U3985E	118U3985E	118U3985E	118U3985E	118U3985E	118U3985E	118U3985E
Filter drier	Code	023Z5040	023Z5040	023Z5040	023Z5041	023Z5041	023Z5045	023Z5045	023Z5040	023Z5040
	Model	DML083	DML083	DML083	DML084	DML084	DML165	DML165	DML083	DML083
Sight glass	Code	014L0172	014L0172	014L0172	014L0173	014L0173	014L0174	014L0174	014L0172	014L0172
	Model	SGP 10	SGP 10	SGP 10	SGP 12	SGP 12	SGP 16	SGP 16	SGP 10	SGP 10
Pressure switch codes	HP - Cartridge	061F6067	061F6067	061F6067	061F6067	061F6067	061F6067	061F6067	061F6067	061F6067
	LP - KP1	060-110166	060-110166	060-110166	060-110166	060-110166	060-110166	060-110166	060-110166	060-110166
Crankcase heater		7303292P01A	7303292P01A	7303292P01A	7303292P01A	7303292P01A	7303292P01A	7303292P01A	7303292P01A	7303292P01A

**Scroll compressor**

Condensing unit		HPUS015	HPUS019	HPUS021	HPUS026	HPUS030	HPUS038	LPZS013	LPZS015	LPZS018
Oil compressor	R404A/R507	120Z5034	120Z5034	120Z5034	120Z5034	120Z5034	120Z5034	120Z5035	120Z5035	120Z5035
Condenser		021Z0590E	021Z0591E	021Z0591E	021Z0592E	021Z0592E	021Z0592E	021Z0592E	021Z0592E	021Z0592E
Fan motor		119-7401E	119-7401E	119-7401E	119-7401E	119-7401E	119-7401E	119-7401E	119-7401E	119-7401E
Fan blade		191U139420E	191U139420E	191U139420E	191U139420E	191U139420E	191U139420E	191U139420E	191U139420E	191U139420E
Fan grill		118U3985E	118U3985E	118U3985E	118U3985E	118U3985E	118U3985E	118U3985E	118U3985E	118U3985E
Filter drier	Code	023Z5040	023Z5041	023Z5041	023Z5045	023Z5045	023Z5045	023Z5045	023Z5045	023Z5045
	Model	DML083	DML084	DML084	DML165	DML165	DML165	DML165	DML165	DML165
Sight glass	Code	014L0172	014L0173	014L0173	014L0174	014L0174	014L0174	014L0174	014L0174	014L0174
	Model	SGP 10	SGP 12	SGP 12	SGP 16	SGP 16	SGP 16	SGP 16	SGP 16	SGP 16
Pressure switch codes	HP - Cartridge	061F6067	061F6067	061F6067	061F6067	061F6067	061F6067	061F6067	061F6067	061F6067
	LP - KP1	060-110166	060-110166	060-110166	060-110166	060-110166	060-110166	060-110166	060-110166	060-110166
Crankcase heater		120Z5040	120Z5040	120Z5040	120Z5040	120Z5040	120Z5040	120Z5040	120Z5040	120Z5040

**Electrical components**

Type	Condensing unit	230V 1Ph (N)				230V 3Ph (Q)		380V 3Ph (V)		Fan capacitor 220V 1Ph	
		Relay	Run - 440Vac		Contactor	Relay phase inversion	Contactor	Relay phase inversion	Contactor	Code	Model
			Model	Start - 330V							
Recip	HPM(Z)P019	8173024	25MFD	88-108MFD	25A	----	18A	----	9A	119-7394	5MFD
	HPM(Z)P022	8173024	45MFD	88-108MFD	25A	----	18A	----	9A	119-7394	5MFD
	HPM(Z)P028	8173024	50MFD	135MFD	25A	----	18A	----	9A	119-7394	5MFD
	HPM(Z)P036	8173024	45MFD	88-108MFD	25A	----	18A	----	12A	119-7394	5MFD
	HPM(Z)P040	8173024	55MFD	135MFD	32A	----	18A	----	12A	119-7394	5MFD
	HPM(Z)P050	8173024	45MFD	135MFD	38A	----	32A	----	18A	119-7394	5MFD
	HPM(Z)P064	8173024	55MFD	235MFD	45A	----	32A	----	18A	119-7394	5MFD
	LPZP048	8173024	25MFD	88-108MFD	25A	----	18A	----	9A	119-7394	5MFD
	LPZP068	8173024	50MFD	135MFD	25A	----	18A	----	9A	119-7394	5MFD
Scroll	HPUS015	120Z0396	40MFD	145-175MFD	25A	120Z0585	18A	120Z0585	9A	119-7394	5MFD
	HPUS019	120Z0396	70MFD	145-175MFD	25A	120Z0585	18A	120Z0585	18A	119-7394	5MFD
	HPUS021	120Z0396	70MFD	145-175MFD	25A	120Z0585	18A	120Z0585	18A	119-7394	5MFD
	HPUS026	120Z0397	70MFD	145-175MFD	32A	120Z0585	25A	120Z0585	18A	119-7394	5MFD
	HPUS030	120Z0397	50MFD	161-193MFD	50A	120Z0585	25A	120Z0585	18A	119-7394	5MFD
	HPUS038	120Z0398	55MFD	100MFD	50A	120Z0585	25A	120Z0585	18A	119-7394	5MFD
	LPZS013	----	----	----	----	120Z0585	25A	120Z0585	18A	119-7394	5MFD
	LPZS015	----	----	----	----	120Z0585	32A	120Z0585	18A	119-7394	5MFD
	LPZS018	----	----	----	----	120Z0585	32A	120Z0585	18A	119-7394	5MFD

OP-HPMP019-28, OP-HPZP019-28, OP-HPUS015, LPZP048-68

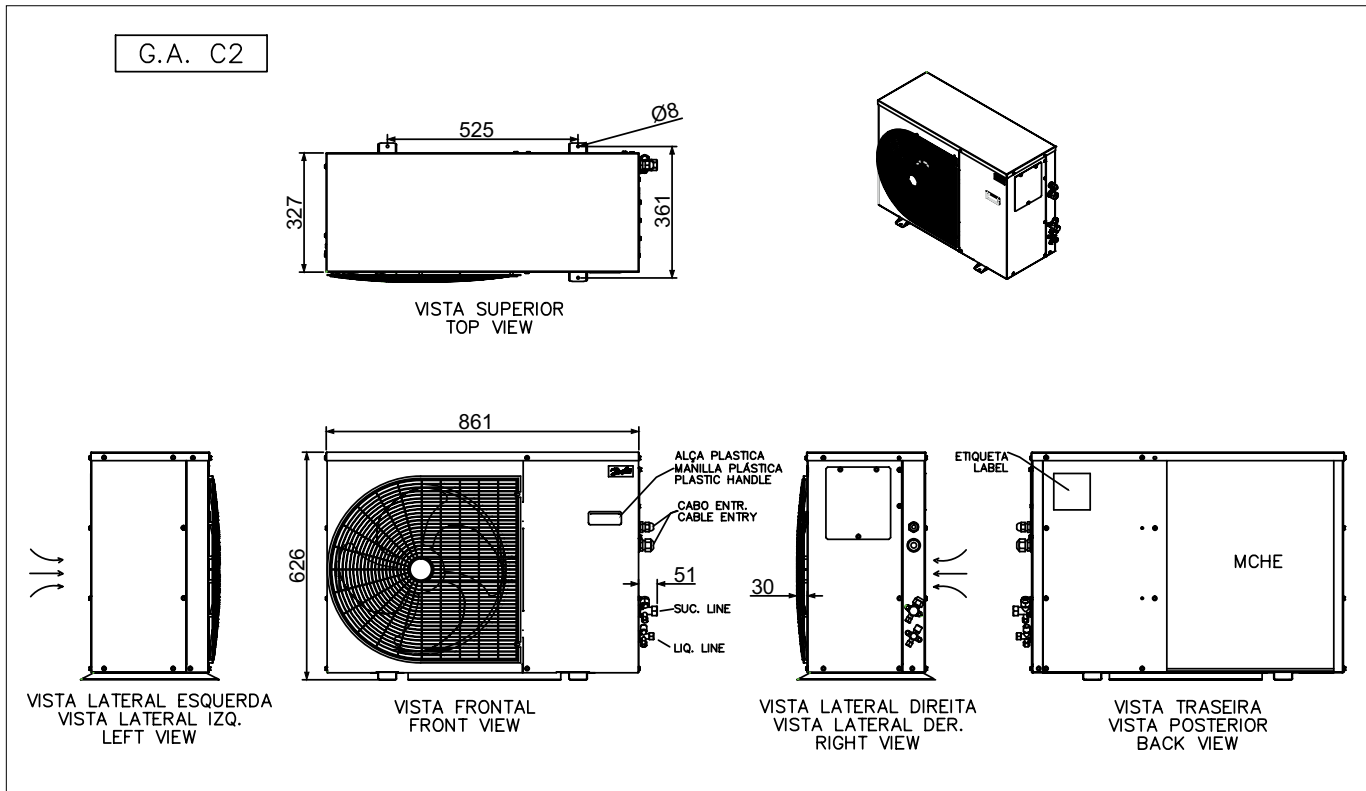

OP-HPMP036-40, OP-HPZP036-40, OP-HPUS019-21

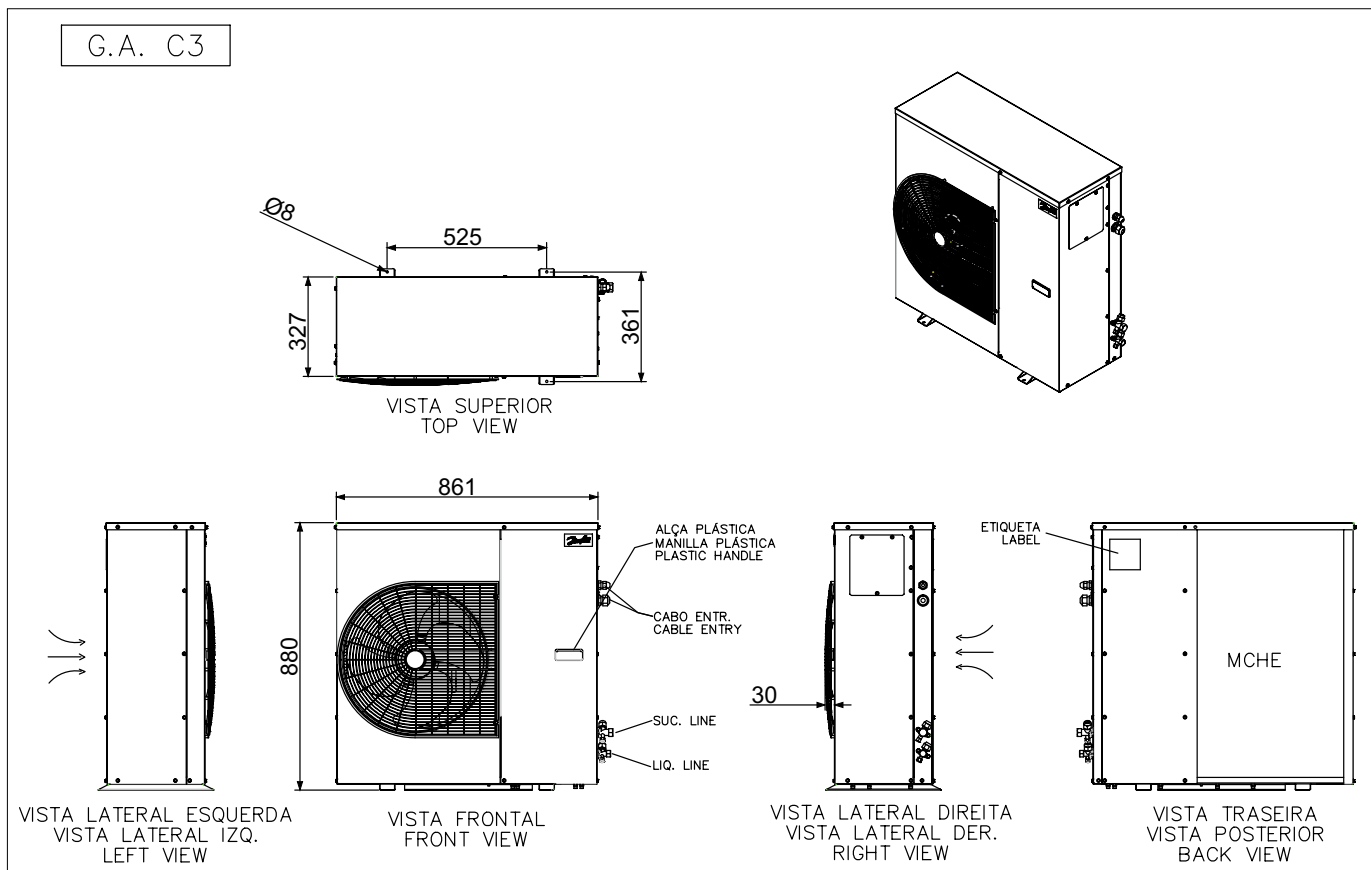



OP-HPMP050-064, OP-HPZP050-064, OP-HPUS026-038, LPZP013-018

G.A. C4

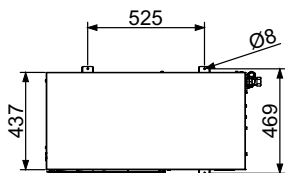

VISTA SUPERIOR  
TOP VIEW

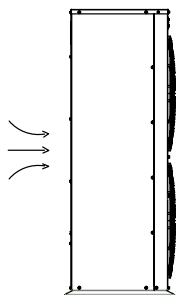
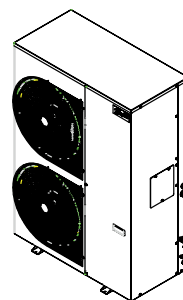

VISTA LATERAL ESQUERDA  
VISTA LATERAL IZQ.  
LEFT VIEW

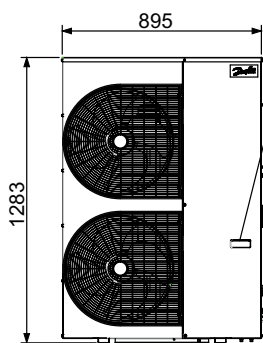

VISTA FRONTAL  
FRONT VIEW

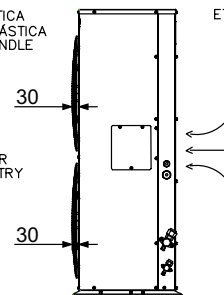

VISTA LATERAL DIREITA  
VISTA LATERAL DER.  
RIGHT VIEW

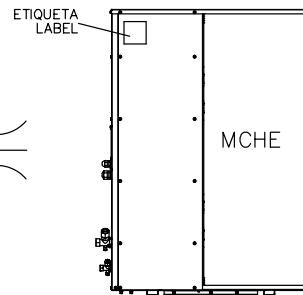

VISTA TRASEIRA  
VISTA POSTERIOR  
BACK VIEW

Code N: HPMP, HPZP, LPZP

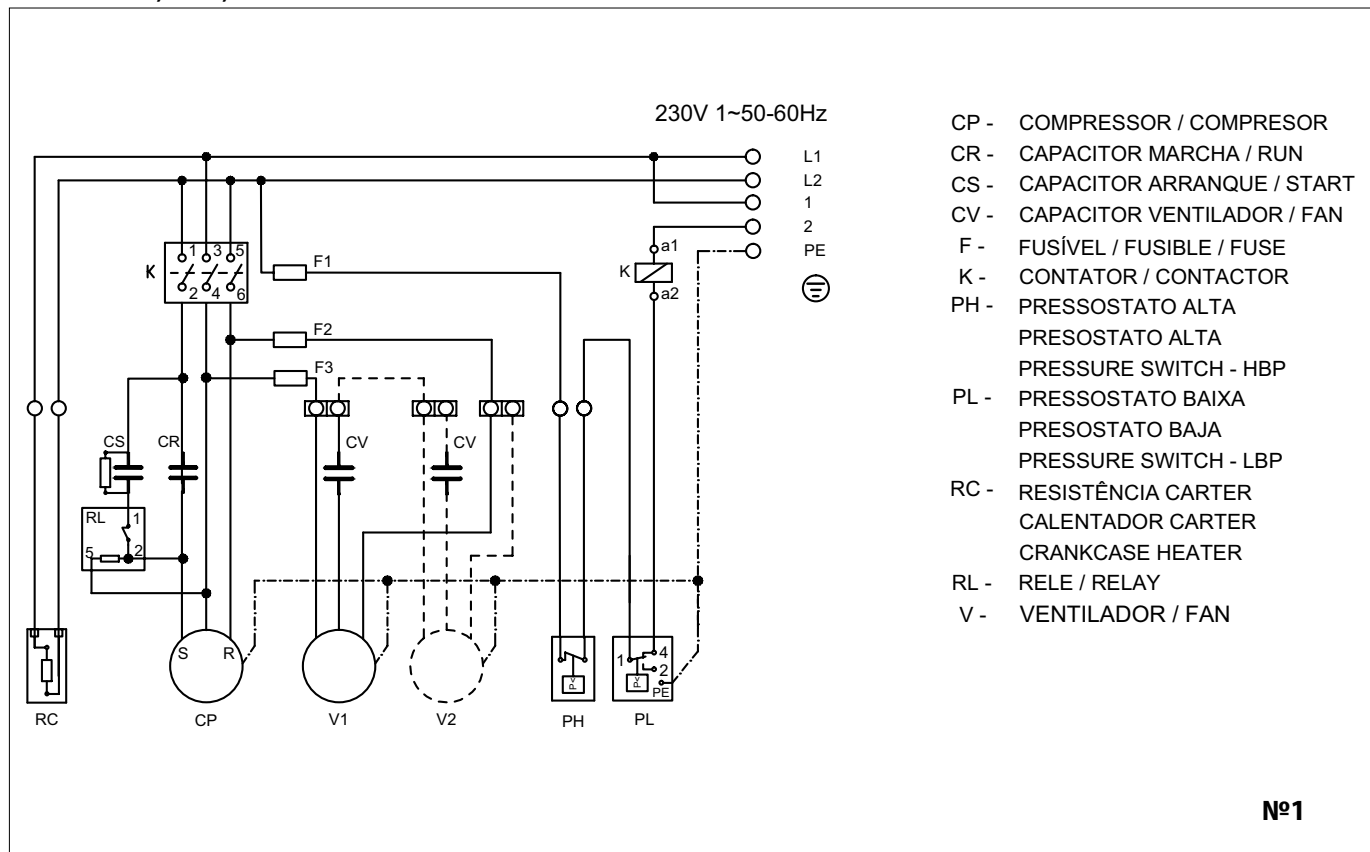

Code N: HPUS

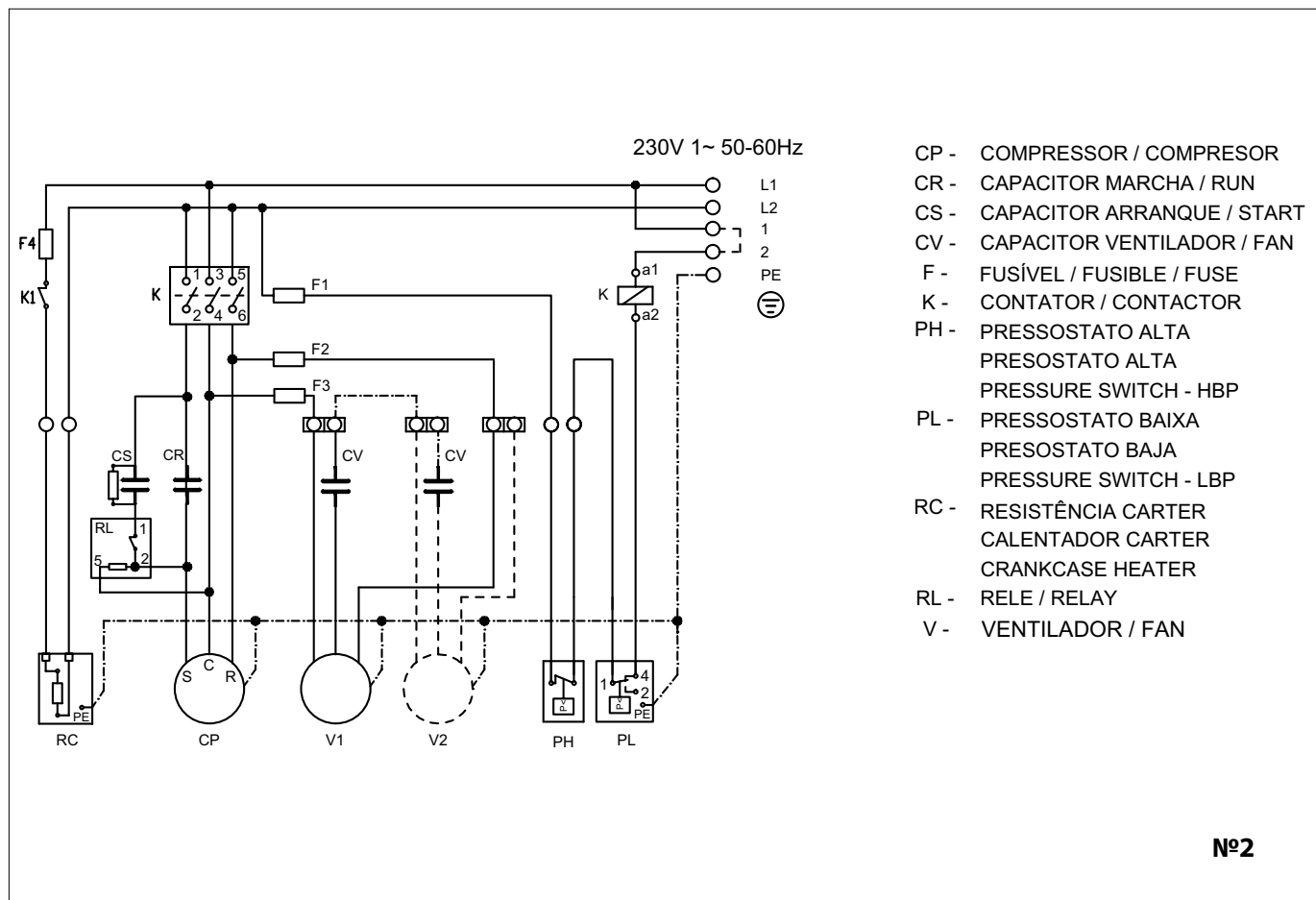

Code Q: HPMP, HPZP, LPZP

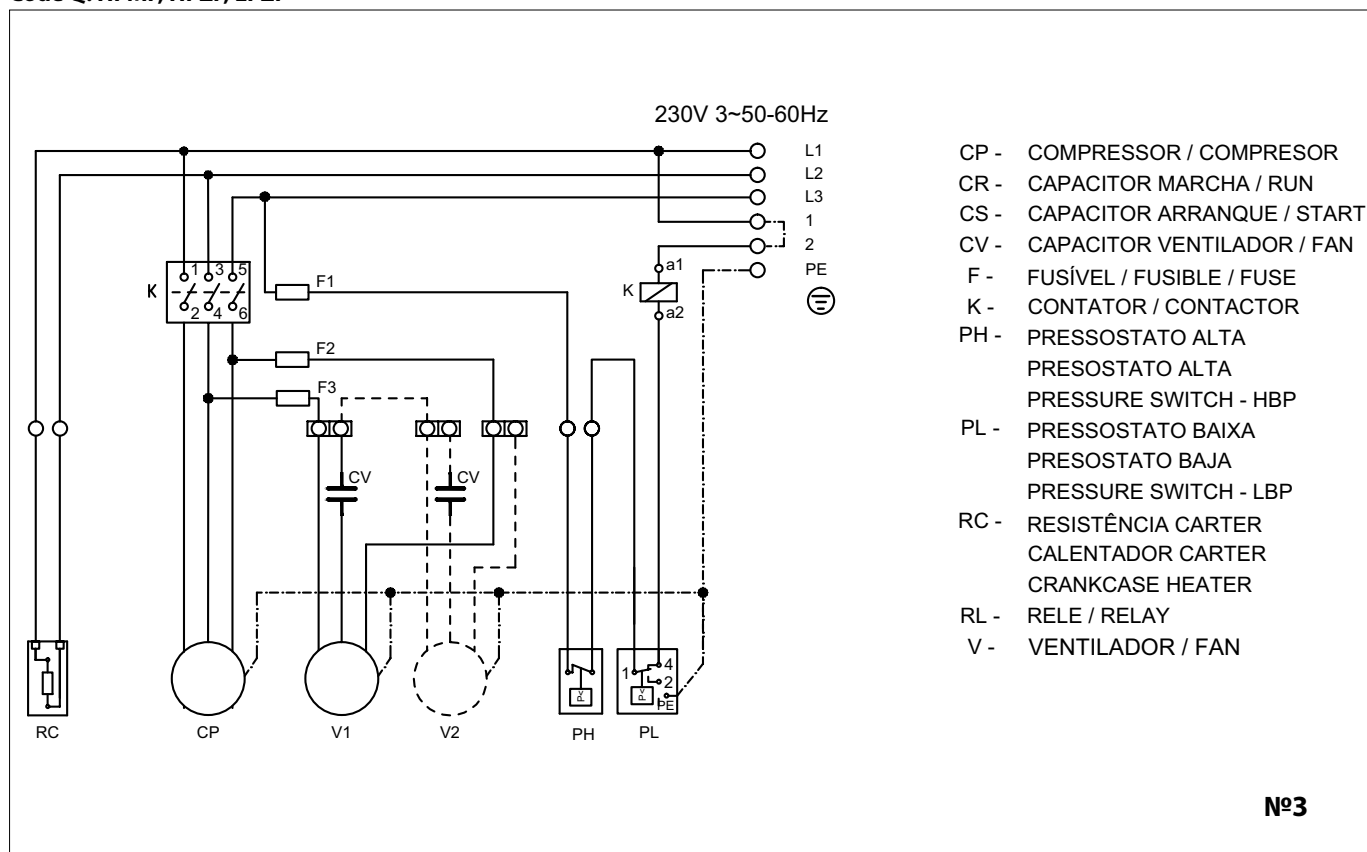

Code Q: HPUS, LPZS

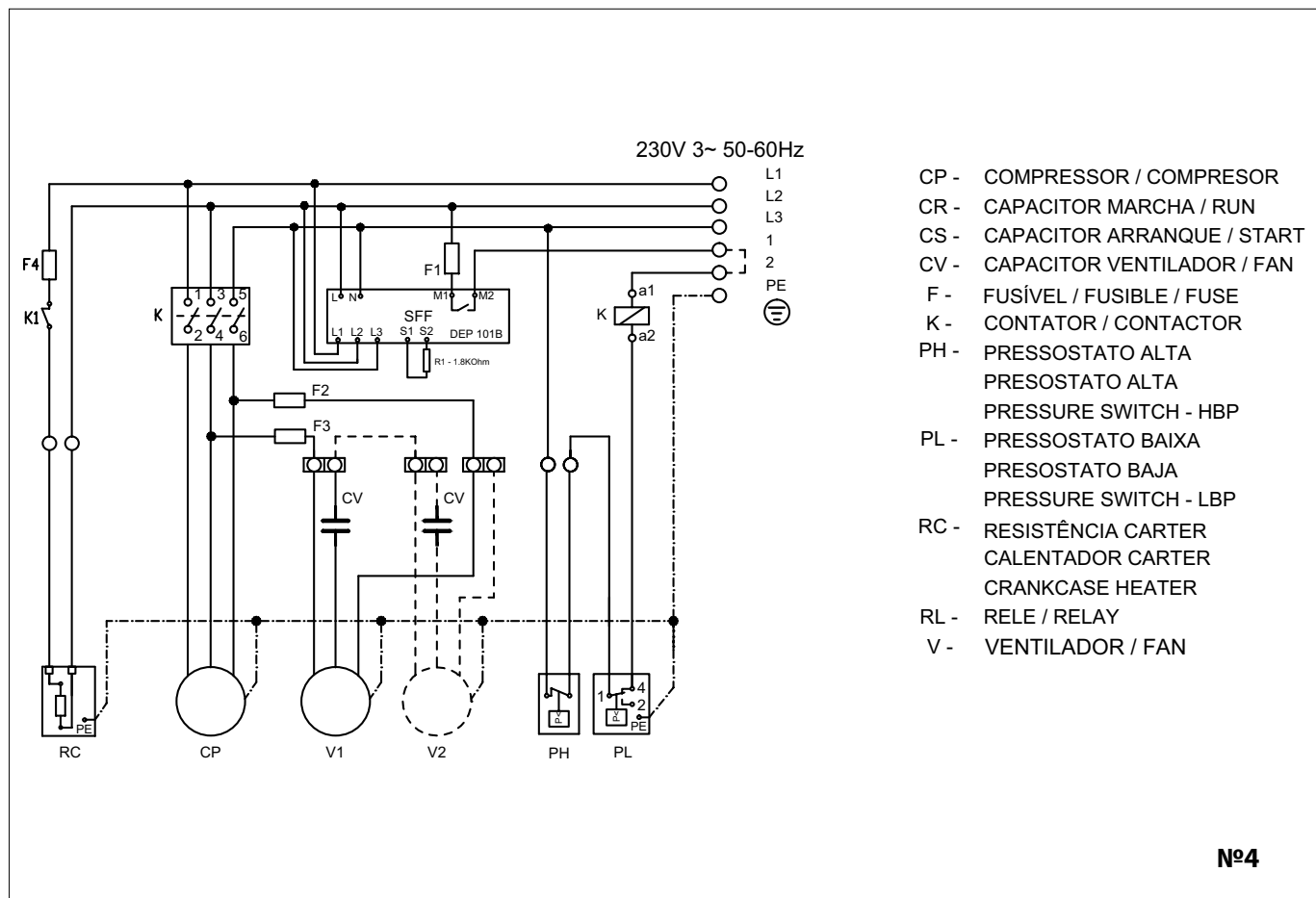

Code V: HPMP, HPZP, LPZP

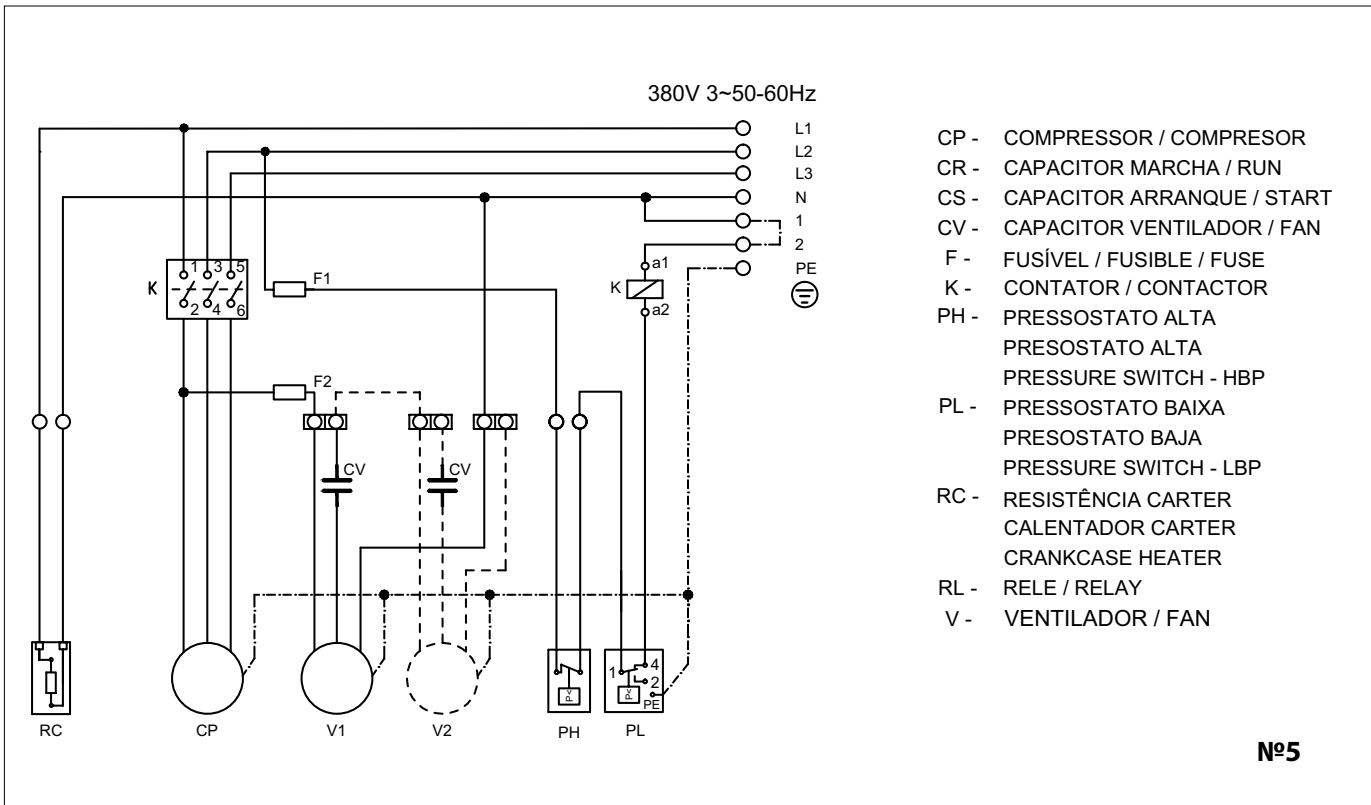

Code V: HPUS, LPZS

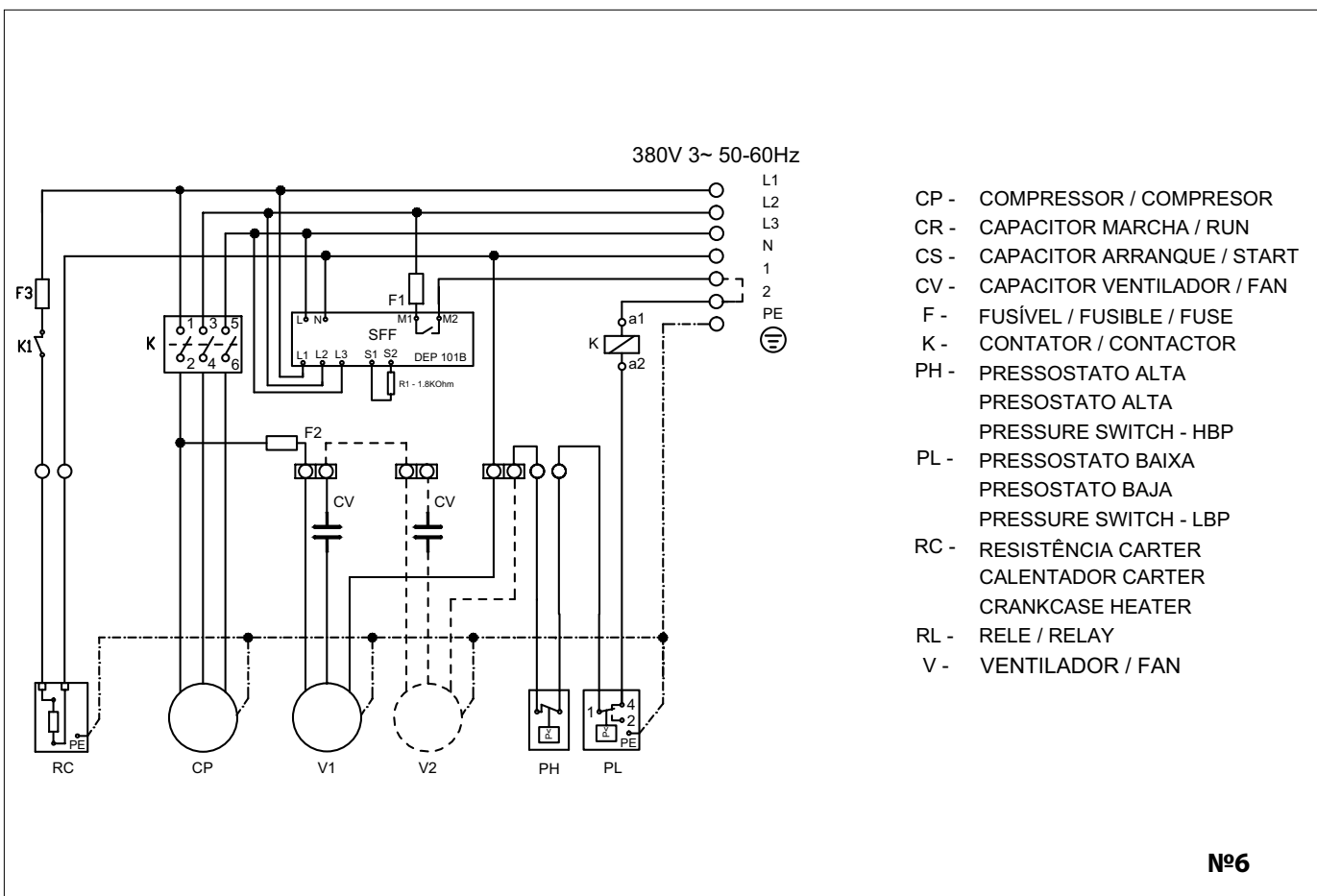







# Danfoss Commercial Compressors

is a worldwide manufacturer of compressors and condensing units for refrigeration and HVAC applications. With a wide range of high quality and innovative products we help your company to find the best possible energy efficient solution that respects the environment and reduces total life cycle costs.

We have 40 years of experience within the development of hermetic compressors which has brought us amongst the global leaders in our business, and positioned us as distinct variable speed technology specialists. Today we operate from engineering and manufacturing facilities spanning across three continents.



Danfoss Scrolls



Danfoss Inverter Scrolls



Danfoss Turbocor Compressors



Danfoss Light Commercial Refrigeration Compressors



Danfoss Maneurop Reciprocating Compressors



Danfoss Optyma Condensing Units

Our products can be found in a variety of applications such as rooftops, chillers, residential air conditioners, heatpumps, coldrooms, supermarkets, milk tank cooling and industrial cooling processes.

<http://cc.danfoss.com>

Danfoss Commercial Compressors, BP 331, 01603 Trévoux Cedex, France | +334 74 00 28 29



Danfoss can accept no responsibility for possible errors in catalogues, brochures and other printed material. Danfoss reserves the right to alter its products without notice. This also applies to products already on order provided that such alterations can be made without subsequential changes being necessary in specifications already agreed. All trademarks in this material are property of the respective companies. Danfoss and the Danfoss logotype are trademarks of Danfoss A/S. All rights reserved.